

Name: _____
Class: _____

Measurement Quiz

Directions 1-4: Below are four pictures of triple beam balances labeled 1-4. In the spaces provided below the pictures, write in the mass shown by each picture.

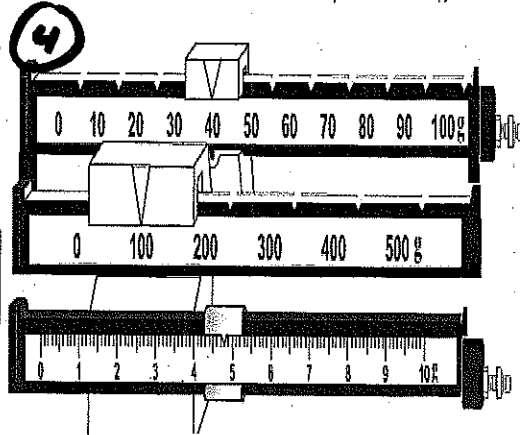
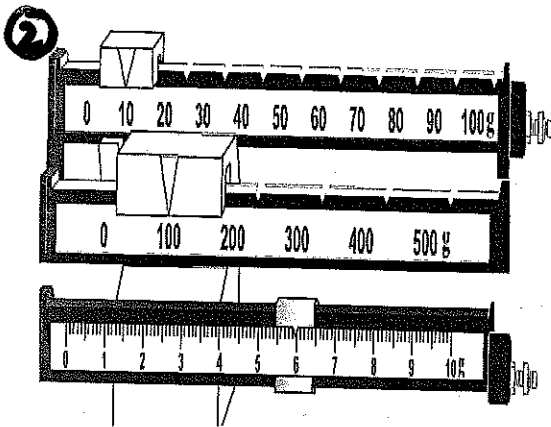
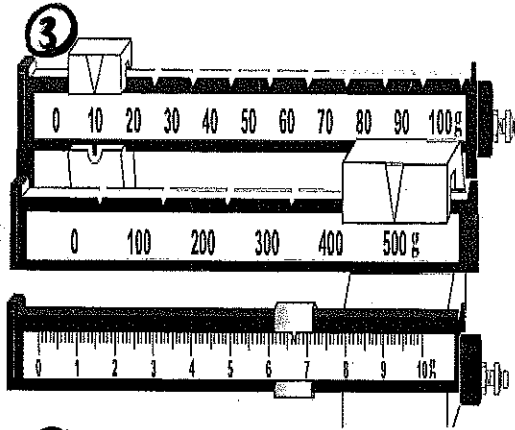
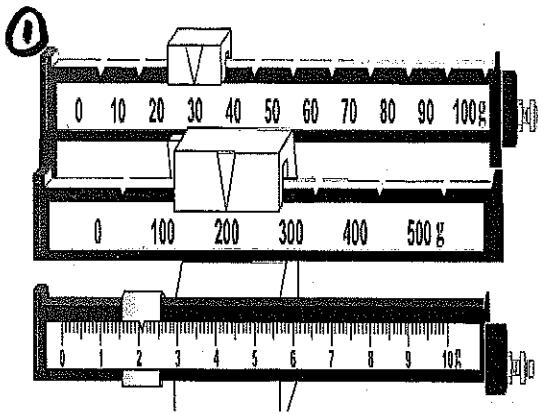

- 1.
- 2.
- 3.
- 4.

Directions 4-8: Below are four pictures of graduated cylinders labeled provided below the pictures, write in the volume shown in each picture.

In the spaces

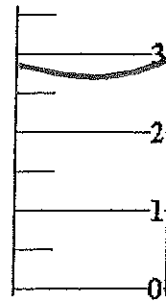
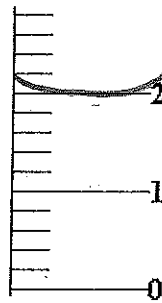
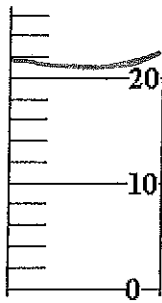
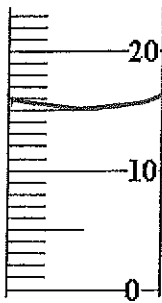

Directions 9-12: Below are four pictures of thermometers labeled 9-12. In the spaces provided below the pictures, write the temperature shown in each picture.

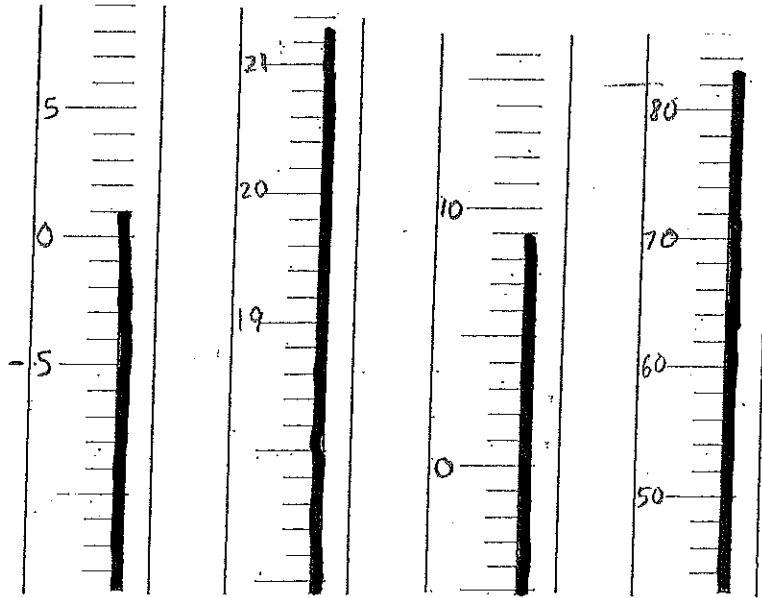

9. _____ 10. _____ 11. _____ 12. _____

Directions 13-16: Below are four pictures of rulers labeled 13-16. In the spaces provided below the pictures, write the lengths shown in each picture.

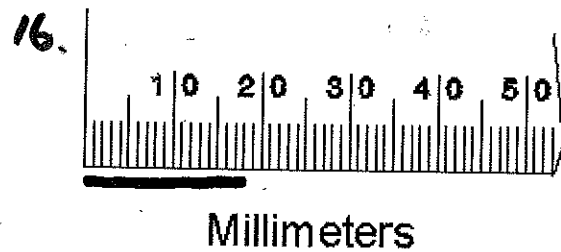
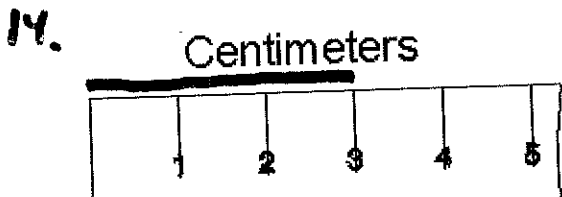
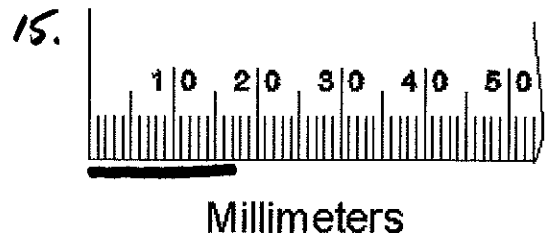
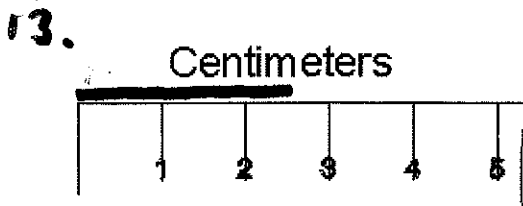

13. _____ 15. _____
 14. _____ 16. _____

Measurement Test (Mod) Name:

A) Ruler

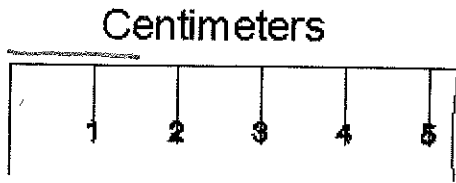

1. _____ cm

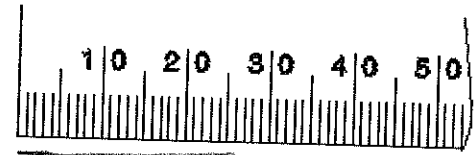

2. _____ mm

B) Graduate

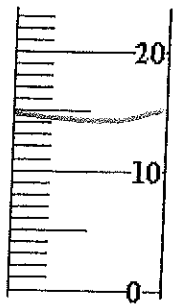

3. _____ ml

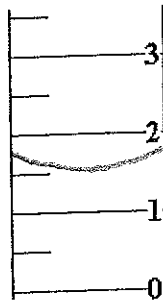

4. _____ ml

C) Balance

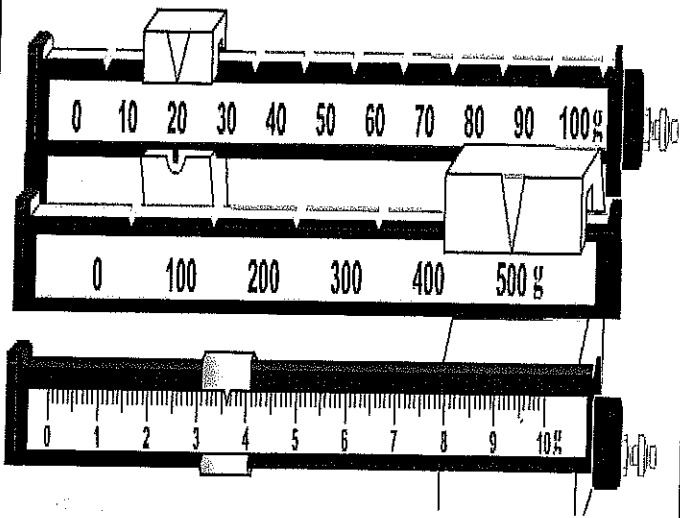

5. _____ g

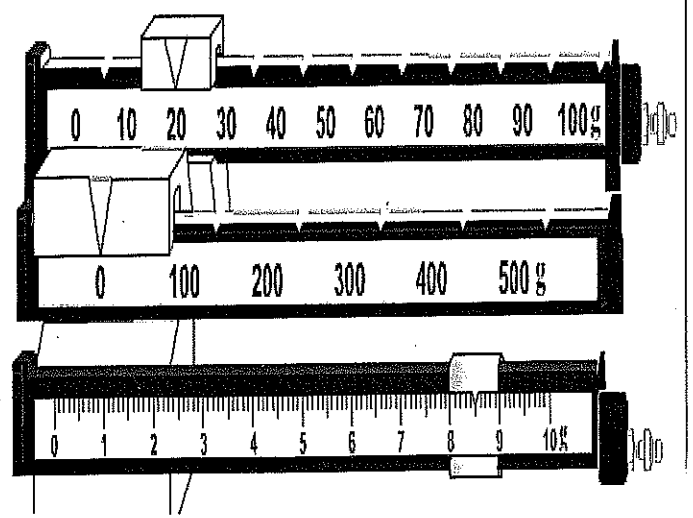

6. _____ g